

REV. 2

ALUMINA 10 ALX

520 - 2 - 35

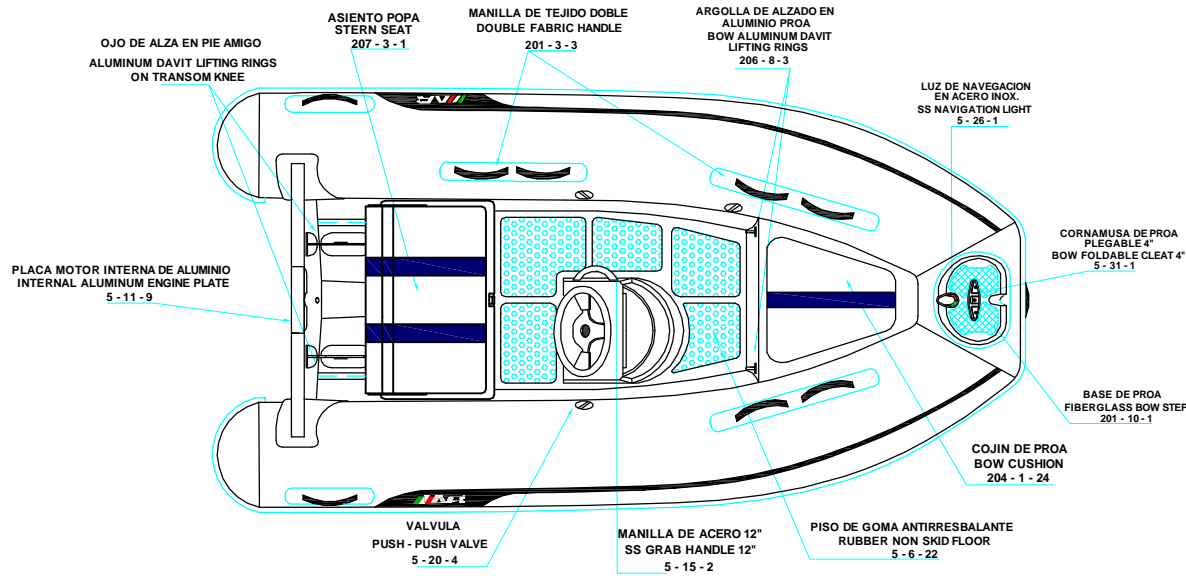

**PLANT VIEW
VISTA SUPERIOR**

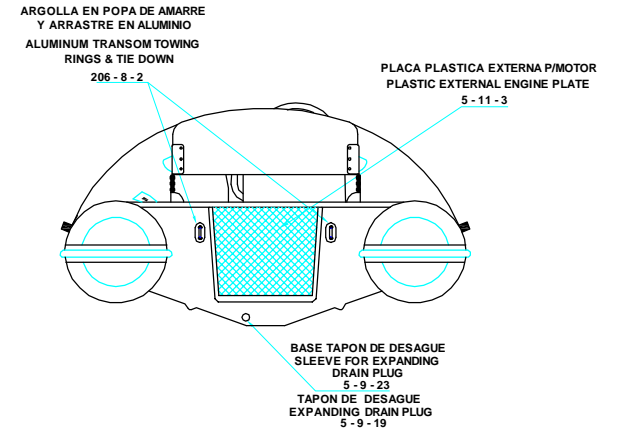

**AFT VIEW
VISTA TRASERA**

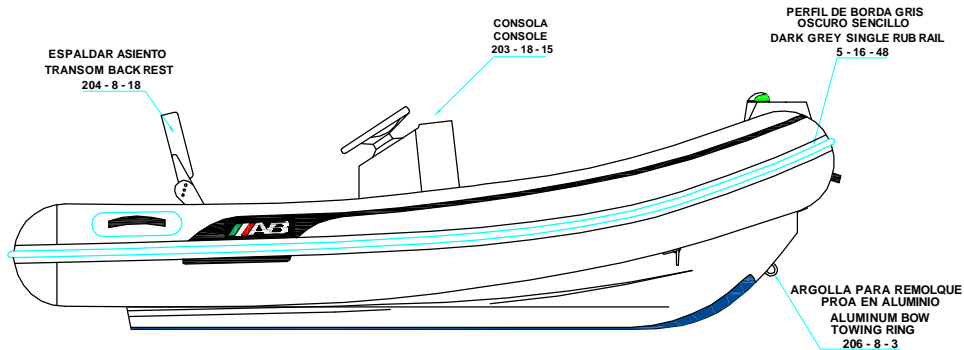

**LONGITUDINAL PROFILE
VISTA LATERAL**

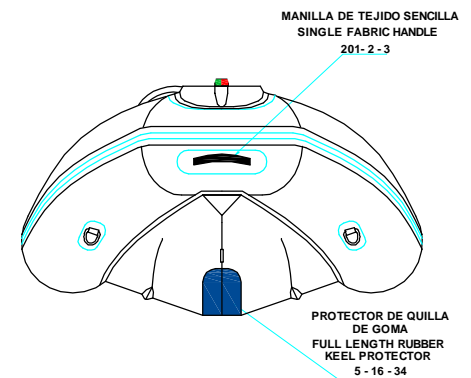

**FORE VIEW
VISTA FRONTAL**

NOTA: FAVOR INDICAR COLOR DEL BOTE AL ORDENAR / **NOTE:** MUST INDICATE BOAT COLOR WHEN ORDERING